



Commercial

Focus, Focus V, Nova, Cube, EL, CVG, UNI, UNI S

DK Original
Brugsanvisning

GB User instructions

D Gebrauchsanweisung

IT Istruzioni per
l'utente

FR Istruzioni per
l'utente

ES Instrucciones para
el Usuario

Before using the machine, all information in this user manual should be read carefully and understood.







Ensure that the instructions below are read and understood, kept up to date according to the machine, and that the instructions are always followed when working with or servicing the machine.







NOTE!



This user manual contains instructions on the installation, commissioning, operation, and maintenance of the machine.

The instructions are provided by the manufacturer to ensure information is available and to show the tasks that must always be performed.

Content

1	Introduction	5
1.1	Purpose	5
1.2	Reading instructions	5
1.2.1	Symbol Explanations	6
1.3	Manufacturer	8
1.4	Machine designation.....	8
1.5	Machine label.....	8
1.6	User Groups and Qualifications	9
1.6.1	Users	9
1.6.2	Maintenance Staff.....	10
2	Safety  	11
2.1	Dangerous Situations in Intended Use.....	11
2.2	Predictably dangerous Use	11
2.2.1	Safety guards.....	11
2.2.2	Restricted Access	13
2.2.3	Placement of Safety Symbols and Pictograms on the Machine	14
2.2.4	Renewal of Safety Symbols and Pictograms	14
3	Overview of the Machine  	15
3.1	Intended Use.....	15
3.2	Uses That Are Not Allowed	15
3.3	Technical Specifications	16
3.3.1	Lifespan, the machine	25
3.4	Use, placement, and arrangement	25
4	Transport, Handling, and Storage  	26
4.1.1	Personal Protective Equipment	26
4.1.2	Education and Equipment.....	26

4.2	Storage.....	27
4.2.1	Environmental Conditions for Storage.....	27
5	Assembly, Installation, and Commissioning  	28
5.1	Electrical Power Supply Connection	28
5.2	Commissioning.....	28
6	Operation   	29
6.1	Controls.....	29
6.1.1	Front Panel.....	29
6.2	Replenishment	32
6.2.1	Starting and Shutting Down the Machine.....	32
7	Inspection, testing, and maintenance 	33
7.1	Used substances, properties.....	33
7.2	Safe execution of maintenance operations	34
7.2.1	Personal protective equipment	34
7.2.2	Lifting and handling of machine parts	34
7.3	Energy Control	35
7.3.1	Disconnection and Lockout.....	35
7.4	Inspections, Testing, and Maintenance of the Machine and Its Components 35	
7.5	Spare Parts/Accessories.....	38
8	Cleaning 	39
8.1.1	Interruption, relief, or isolation of energy	39
8.1.2	Cleaning Procedures - General Cleaning.....	39
8.1.3	Cleaning Procedures - Defrosting	40
8.1.4	Extra Cleaning Procedures - FOCUS	40

9	Dismantling, Removal from Operation, and Scrapping	
		41
9.1	Disconnection, Relieving, or Isolation of Energy Sources	41
9.2	Special risk reduction measures	41
9.3	Personal Protective Equipment	42
9.4	Sequence or time schedule for decommissioning operations.....	43
9.5	Dismantling	43
9.6	Disposal, Destruction, and Recycling	43
10	Documents and Drawings 	44
10.1	Copy of the CE Declaration of Conformity	44
10.2	Electrical documentation	46
11	Appendix	47
11.1	List of Spare parts	47
11.1.1	CUBE.....	47
11.1.2	NOVA.....	48
11.1.3	FOCUS	50
11.1.4	FOCUS V	52
11.1.5	CVG.....	53
11.1.6	EL.....	55
11.1.7	UNI	57
11.2	Assembly drawings and diagrams.....	60
11.2.1	NOVA/CUBE	60
11.2.2	FOCUS, FOCUS V	62
11.2.3	CVG.....	63
11.2.4	EL.....	63
11.2.5	UNI (S)	64

1 Introduction

1.1 Purpose

The purpose of this user manual is to ensure proper use of the machine, including installation, operation, handling, cleaning, maintenance, dismantling, and disposal.

This user manual is an integral part of the machine, providing users with the necessary information to use the machine properly and safely.

If changes are made to the machine, the user manual and risk assessment must be reviewed again and revised if necessary.

1.2 Reading instructions

This user manual has been prepared in accordance with the Machinery Directive 2006/42/EC and EN ISO 20607 Safety of machinery - Instruction manuals - General principles of development.

The user manual provides the user with the information necessary for safe and efficient use of the machine throughout its lifecycle. General safety instructions and precautions are described in a standalone section.





The user manual is aimed at all users of the machine and is divided according to the users' functions and work with the machine. Safety-related information and instructions are either presented as divided sections or as general information to all users.

When reviewing the user manual, the following approach is recommended:
Identify yourself with one or more user groups before using the machine.







Read and understand the contents of the user manual, including information and instructions, if necessary, only those directed to the relevant user group.

1.2.1 Symbol Explanations





The following symbols are used throughout the user manual:

Symbol	Symbol explanations
	<p>Attention. Attention required. Indicates required action for establishing safe working conditions or use.</p>
	<p>Reference to documentation Reference to relevant information in this or another user manual/safety data sheet.</p>
	<p>General warning Attention required, warning about potential hazards. (Description of hazard sources, safety measures, etc. is provided where relevant)</p>
	<p>Information for users Indicates chapters, information, etc., targeted at, but not limited to, the users.</p>
	<p>Information for maintenance personnel Indicates chapters, information, etc., targeted at, but not limited to, maintenance personnel.</p>

Safety symbols and pictograms are used to warn and/or inform different user groups. The symbols have the following meanings:

Geometrical forms	Meaning	Safety color	Contrast to the safety color	Color of the graphic symbol	Example of use
	Prohibition	Red	White	Black	 Do not touch
	Injunction	Blue	White	White	 Hearing protection required
	Warning	Yellow	Black	Black	 Electric voltage

The following colors are used in the manual to catch the users' attention, to communicate the level of danger, and to highlight areas where extra caution is needed.

	Danger	Indicates a high risk which, if not avoided, will result in serious injury or death.
	Warning	Indicates a medium risk which, if not avoided, could result in serious injury or death.
	Careful	Indicates a low risk which, if not avoided, could result in minor to moderate injury.
	Attention	Indicates the reader should pay attention to the following information.

1.3 Manufacturer

This machine is manufactured by:

Company-name: Elcold Fryserne Hobro ApS

Address: Loegstoervej 81, DK-9500 Hobro

Tlf.: +45 96 57 22 22

Mail: info@elcold.com

Website: www.elcold.com

1.4 Machine designation

The full designation of the machine is: Focus, Focus V, Nova, Cube, EL, CVG, UNI, UNI S (herein-after collectively referred to as "the machine").

1.5 Machine label

A machine plate similar to the one below can be found on the back of the freezer.

NO: 56200259	TYPE: NOVA 45
	CODE: 2BC100A
VOL.BR. 426	
Volt: 220-240 Watt: 203 Amp: 4 Hz50	
FREEZ.CAP:	kWh/24h. 1,414
CLASS CC.B	R290 80GR.
TEMP.RISE TO 0 C	IN 0 HOURS
FUSE RATING AMP.	TM05 08/05
GWP 3	PO126728.1
CO2-equivalent 0T	

This is hermetically sealed equipment



NOVA 45

MADE IN DENMARK BY ELCOLD FREEZER ApS.

ELCOLD
VIDEO
INSTRUCTIONS

02 *Figure 1 – Machine label located on the back of the freezer*

1.6 User Groups and Qualifications

Users of the machine must identify themselves with a user group, divided according to their user interface and tasks related to the use of the machine, including the entire lifecycle of the machine. The information and instructions in the user manual are divided according to user groups and are marked using symbols, see below.

1.6.1 Users

Work tasks, instructions, etc. addressed to the User are marked with:



Users are individuals who:

- Physically use the machine and/or its control system during normal operation.
- Are capable of performing standard adjustments on the machine.

Requirements for User and Qualifications

Users must, in the use of the machine, comply with the following requirements:

- Have read and understood the user manual as well as any attached guides, safety instructions, etc.
- Acquire knowledge of the machine's functions and safety measures. This is achieved by thoroughly reading the user manual as well as any attached guides, safety instructions, etc.

Before starting or servicing the machine, the operators must be informed about all installed safety measures, see the section on Safety Features, overview.

1.6.2 Maintenance Staff

Work tasks, instructions, etc. addressed to the maintenance staff are marked with:



Maintenance staff are individuals who:

- Are tasked with remedying and fixing faults and deficiencies on the machine.
- Are tasked with ensuring that the machine is in a safe operational condition.
- Maintain and service the machine according to the manufacturer's instructions and the directions in this manual.
- Are qualified through professional education (e.g., electrician) or through training that equates them with such qualifications

Requirements for maintenance personnel and qualifications

Maintenance personnel must be trained/instructed in the use of the machine according to the following requirements:

- Must have read and understood the manual as well as any attached guidelines, safety instructions, etc.
- Acquire knowledge of the machine's functions and safety precautions. This can be achieved through side-by-side training or by reading the manual as well as any attached guidelines, safety instructions, etc.
- Possess full mobility and be generally physically well-functioning.





Before commencing work, maintenance personnel must be instructed in safety precautions concerning the machine. New maintenance personnel must be trained by an experienced colleague.

	Warning!
	Improper maintenance can be dangerous and, in the worst case, lead to fatalities!



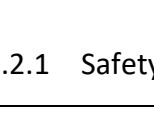

The machine may only be used as intended. If the machine is used for other purposes, or if modifications are made to the construction, the supplier does not vouch for the safety of the machine.

2.1 Dangerous Situations in Intended Use

	Warning!
	Keep all vent openings in the device's casing or in the built-in structure free from obstructions.
	Warning!
	Do not use mechanical devices or other means to accelerate the defrosting process, other than those recommended by the manufacturer.
	Warning!
	Do not use electrical appliances inside the food/ice storage compartments, unless they are of the type recommended by the manufacturer.

2.2 Predictably dangerous Use

2.2.1 Safety guards

	Warning!
	Serious injuries may occur as a result of missing or defective shielding. Direct contact with moving parts can result in minor injuries.

The machine's shielding may only be bypassed by users or maintenance personnel who are instructed in the use of the machine and are aware of the risks associated with the use of the machine.

Before starting the machine, the user must generally inspect the machine for visible defects that may reduce safety during operation.

2.2.2 Restricted Access

	Warning!
	Using the surfaces of the machine as access routes can lead to fall accidents or collapse of the machine/machine part, resulting in personal injury.



It is not permitted to use the surfaces of the machine as access routes unless they are designed for it.

The machine must not be used for:

- Standing or climbing on, etc.
- External surfaces for storage, workspace, or similar.

2.2.3 Placement of Safety Symbols and Pictograms on the Machine

All safety symbols, safety signs, and pictograms and their placement on the machine are described in the table below:

Symbol, Sign, or Pictogram	Description		Placement
	Danger	For Electrical Shock	Shielding for the Compressor Room
	Danger	For Release of Flammable Gases	Shielding for the Compressor Room

2.2.4 Renewal of Safety Symbols and Pictograms

	Lack of Labeling for Remaining Risks
	In the case of missing, damaged, or otherwise illegible labels and warnings, dangerous situations can arise, whereby operators or maintenance personnel may sustain serious injuries.

- Replace broken or missing warning or instructional signs and labels. Place these in their original locations.
- Never remove warning or instructional signs and labels from the machine, as this may prevent the communication of important safety-related information.

2.2.4.1 Fire Extinguishing Equipment

In the event of a fire in the facility, one of the following fire extinguishing agents should be used:

- Powder
- CO₂
- Another extinguishing agent suitable for class C fires (ISO 3941:2007)

Assess the hazards and sources of danger associated with the fire. In case of personal danger, escape routes should be used and emergency services contacted.

3 Overview of the Machine



The machine consists of the following main components:

- Compressor
- Fan
- Freezing chamber
- Thermostat

3.1 Intended Use

The machine is used to freeze pre-packaged ice cream products.

3.2 Uses That Are Not Allowed

The machine may only be used as described.

If modifications are made to the machine, the user manual and risk assessment must be reviewed again and amended if necessary.

The machine must be taken out of operation as soon as any faults or defects are detected that could pose a safety and health risk. The machine may not be used until the detected faults or defects have been corrected.

The machine must not be used for freezing the product.

3.3 Technical Specifications

<i>Elcold model</i>	<i>Focus 73-2BD10LA</i>	<i>Focus 73-2BC100A</i>	<i>Focus V 73-2BD10LA</i>	<i>Focus V 73-2BC100A</i>
Type [1]	ICFT	ICFT	ICFT	ICFT
Refrigerant [2]	R290	R290	R290	R290
Amount of refrigerant [g] [3]	67	67	67	67
Internal Width [mm] [4]	570	570	570	570
Internal Depth [mm] [5]	500	500	500	500
Internal Height [mm] [6]	699	699	699	699
Compressor Room Height [mm] [7]	250	250	250	250
Compressor Room Width [mm] [8]	200	200	200	200
External Width [mm] [9]	720	720	720	720
External Depth [mm] [10]	650	650	650	650
External Height [mm] [11]	779	779	779	779
Power [12]	220-240 Vac 50Hz + PE	220-240 Vac 50Hz + PE	220-240 Vac 50Hz + PE	220-240 Vac 50Hz + PE
Current consumption [A] [13]	0,385	0,385	0,385	0,385
Input power [W] [14]	84,08	84,08	84,08	84,08
Loadline [mm] [15]	485	485	485	485
Climate Class [16]	B [16°C @ 80%RH] - [35°C @ 75%RH]	B [16°C @ 80%RH] - [35°C @ 75%RH]	B [16°C @ 80%RH] - [35°C @ 75%RH]	B [16°C @ 80%RH] - [35°C @ 75%RH]
Floor Footprint [m²] [17]	0,468	0,468	0,468	0,468
TDA [m²] [18]	0,285	0,285	0,285	0,285
Gross vol. [dm³] [19]	161	161	161	161
Netto vol. [dm³] [20]	113	113	113	113
Temperature [°C] [21]	-18	-18	-18	-18

	Noise Emission [dB(A)]		<70	<70	<70	<70
	[22]					
	Weight [23]		44	44	44	44
	Focus 106- 2BD10LA	Focus 106- 2BD100A	Focus V 106- 2BD10LA	Focus V 106- 2BD100A	Focus 131- 2BD10LA	Focus 131- 2BD100A
[1]	ICFT	ICFT	ICFT	ICFT	ICFT	ICFT
[2]	R290	R290	R290	R290	R290	R290
[3]	75	75	75	75	80	80
[4]	900	900	900	900	1150	1150
[5]	500	500	500	500	500	500
[6]	699	699	699	699	699	699
[7]	250	250	250	250	250	250
[8]	200	200	200	200	200	200
[9]	1050	1050	1050	1050	1300	1300
[10]	650	650	650	650	650	650
[11]	779	779	779	779	779	779
[12]	220-240 Vac 50Hz + PE	220-240 Vac 50Hz + PE	220-240 Vac 50Hz + PE	220-240 Vac 50Hz + PE	220-240 Vac 50Hz + PE	220-240 Vac 50Hz + PE
[13]	0,596	0,596	0,596	0,596	0,655	0,63
[14]	126,56	126,56	126,56	126,56	141,64	136,34
[15]	486	487	488	489	485	485
[16]	B [16°C @ 80%RH] - [35°C @ 75%RH]	B [16°C @ 80%RH] - [35°C @ 75%RH]	B [16°C @ 80%RH] - [35°C @ 75%RH]	B [16°C @ 80%RH] - [35°C @ 75%RH]	B [16°C @ 80%RH] - [35°C @ 75%RH]	B [16°C @ 80%RH] - [35°C @ 75%RH]
[17]	0,683	0,683	0,683	0,683	0,845	0,845
[18]	0,450	0,450	0,450	0,450	0,575	0,575
[19]	270	270	270	270	352	352
[20]	193	193	193	193	254	254
[21]	-18	-18	-18	-18	-18	-18
[22]	<70	<70	<70	<70	<70	<70
[23]	54	54	54	54	62	62

	Focus V 131- 2BD10LA	Focus V 131- 2BD100A	Focus 151- 2BD12LA	Focus 151- 2BD120A	Focus 171- 2CD12LA	Focus 171- 2CD120A
[1]	ICFT	ICFT	ICFT	ICFT	ICFT	ICFT
[2]	R290	R290	R290	R290	R290	R290
[3]	80	80	96	96	94	94
[4]	1150	1150	1350	1350	1550	1550
[5]	500	500	500	500	500	500
[6]	699	699	699	699	699	699
[7]	250	250	250	250	250	250
[8]	200	200	200	200	200	200
[9]	1300	1300	1500	1500	1700	1700
[10]	650	650	650	650	650	650
[11]	779	779	779	779	779	779
[12]	220-240 Vac 50Hz + PE	220-240 Vac 50Hz + PE	220-240 Vac 50Hz + PE	220-240 Vac 50Hz + PE	220-240 Vac 50Hz + PE	220-240 Vac 50Hz + PE
[13]	0,655	0,63	0,965	0,965	1,167625	1,167625
[14]	141,64	136,34	197,7	197,7	234,81875	234,81875
[15]	485	485	485	486	485	485
[16]	B [16°C @ 80%RH] - [35°C @ 75%RH]	B [16°C @ 80%RH] - [35°C @ 75%RH]	B [16°C @ 80%RH] - [35°C @ 75%RH]	B [16°C @ 80%RH] - [35°C @ 75%RH]	C [16°C @ 80%RH] - [40°C @ 40%RH]	C [16°C @ 80%RH] - [40°C @ 40%RH]
[17]	0,845	0,845	0,975	0,975	1,105	1,105
[18]	0,575	0,575	0,675	0,675	0,775	0,775
[19]	352	352	418	418	484	484
[20]	254	254	302	302	351	351
[21]	-18	-18	-18	-18	-18	-18
[22]	<70	<70	<70	<70	<70	<70
[23]	62	62	68	68	74	74

	<i>Nova 22- 2BC10LA</i>	<i>Nova 22- 2BC100A</i>	<i>Nova 35- 2BD10LA</i>	<i>Nova 35- 2BC100A</i>	<i>Nova 45- 2BC10LA</i>	<i>Nova 45- 2BC100A</i>
[1]	ICFT	ICFT	ICFT	ICFT	ICFT	ICFT
[2]	R290	R290	R290	R290	R290	R290
[3]	66	66	68	68	80	80
[4]	606	606	936	936	1186	1186
[5]	536	536	536	536	536	536
[6]	688	688	688	688	688	688
[7]	250	250	250	250	250	250
[8]	200	200	200	200	200	200
[9]	760	760	1090	1090	1340	1340
[10]	690	690	690	690	690	690
[11]	798	798	798	798	798	798
[12]	220-240 Vac 50Hz + PE	220-240 Vac 50Hz + PE	220-240 Vac 50Hz + PE	220-240 Vac 50Hz + PE	220-240 Vac 50Hz + PE	220-240 Vac 50Hz + PE
[13]	0,39	0,39	0,598	0,598	0,526	0,526
[14]	87,01	87,01	128,91	128,91	111,74	111,74
[15]	585	585	585	585	585	585
[16]	B [16°C @ 80%RH] - [35°C @ 75%RH]	B [16°C @ 80%RH] - [35°C @ 75%RH]	B [16°C @ 80%RH] - [35°C @ 75%RH]	B [16°C @ 80%RH] - [35°C @ 75%RH]	B [16°C @ 80%RH] - [35°C @ 75%RH]	B [16°C @ 80%RH] - [35°C @ 75%RH]
[17]	0,524	0,524	0,752	0,752	0,925	0,925
[18]	0,325	0,325	0,502	0,502	0,636	0,636
[19]	205	205	331	331	426	426
[20]	163	163	267	267	345	345
[21]	-18	-18	-18	-18	-18	-18
[22]	<70	<70	<70	<70	<70	<70
[23]	45	45	53	53	61	61

	<i>Nova 53- 2BD12LA</i>	<i>Nova 53- 2BC120A</i>	<i>Nova 61- 2BD12LA</i>	<i>Nova 61- 2BD120A</i>	<i>Cube 22- 2BC100A</i>	<i>Cube 35- 2BD100A</i>
[1]	ICFT	ICFT	ICFT	ICFT	ICFS	ICFS
[2]	R290	R290	R290	R290	R290	R290
[3]	96	96	112	112	66	68
[4]	1386	1386	1646	1646	606	936
[5]	536	536	536	536	536	536
[6]	688	688	688	688	688	688
[7]	250	250	250	250	250	250
[8]	200	200	200	200	200	200
[9]	1540	1540	1800	1800	760	1090
[10]	690	690	690	690	690	690
[11]	798	798	798	798	798	798
[12]	220-240 Vac 50Hz + PE	220-240 Vac 50Hz + PE	220-240 Vac 50Hz + PE	220-240 Vac 50Hz + PE	220-240 Vac 50Hz + PE	220-240 Vac 50Hz + PE
[13]	1,02	1,02	1,173	1,173	0,373	0,562
[14]	214,5	214,5	241,4	241,4	82,16	119,89
[15]	585	585	585	585	585	585
[16]	B [16°C @ 80%RH] - [35°C @ 75%RH]	B [16°C @ 80%RH] - [35°C @ 75%RH]	B [16°C @ 80%RH] - [35°C @ 75%RH]	B [16°C @ 80%RH] - [35°C @ 75%RH]	B [16°C @ 80%RH] - [35°C @ 75%RH]	B [16°C @ 80%RH] - [35°C @ 75%RH]
[17]	1,063	1,063	1,242	1,242	0,524	0,752
[18]	0,743	0,743	0,882	0,882	N/A	N/A
[19]	503	503	602	602	205	331
[20]	408	408	489	489	163	267
[21]	-18	-18	-18	-18	-18	-18
[22]	<70	<70	<70	<70	<70	<70
[23]	68	68	71	71	45	53

	Cube 45- 2BD100A	Cube 53- 2BD120A	Cube 61- 2BD120A	CVG 22- 2BD100A	CVG 35- 2BD100A	CVG 45- 2BD100A
[1]	ICFS	ICFS	ICFS	ICFT	ICFT	ICFT
[2]	R290	R290	R290	R290	R290	R290
[3]	96	96	112	66	80	91
[4]	1186	1386	1646	606	936	1186
[5]	536	536	536	536	536	536
[6]	688	688	688	786	786	786
[7]	250	250	250	250	250	250
[8]	200	200	200	200	200	200
[9]	1340	1540	1800	720	1050	1300
[10]	690	690	690	650	650	650
[11]	798	798	798	846	846	846
[12]	220-240 Vac 50Hz + PE	220-240 Vac 50Hz + PE	220-240 Vac 50Hz + PE	220-240 Vac 50Hz + PE	220-240 Vac 50Hz + PE	220-240 Vac 50Hz + PE
[13]	0,616	0,94	1,104	0,688	0,557	0,7365625
[14]	133,33	196,68	222,6	154,7	119,15	160,8875
[15]	585	585	585	610	610	610
[16]	B [16°C @ 80%RH] - [35°C @ 75%RH]	B [16°C @ 80%RH] - [35°C @ 75%RH]	B [16°C @ 80%RH] - [35°C @ 75%RH]	B [16°C @ 80%RH] - [35°C @ 75%RH]	B [16°C @ 80%RH] - [35°C @ 75%RH]	B [16°C @ 80%RH] - [35°C @ 75%RH]
[17]	0,925	1,063	1,242	0,468	0,683	0,845
[18]	N/A	N/A	N/A	0,325	0,502	0,636
[19]	426	503	602	212	342	440
[20]	345	408	489	171	279	361
[21]	-18	-18	-18	-18	-18	-18
[22]	<70	<70	<70	<70	<70	<70
[23]	61	68	71	43	54	64

	CVG 53- 2BD120A	CVG 61- 2BD120A	CVG 59- 2BD100A	UNI S 11- 2A-110B	UNI S 21- 2A-110B	UNI S 31- 2A-110B
[1]	ICFT	ICFT	ICFT	ICFT	ICFT	ICFT
[2]	R290	R290	R290	R290	R290	R290
[3]	91	110	100	65	74	81
[4]	1386	1586	1456	520	850	1100
[5]	536	536	626	450	450	450
[6]	786	786	786	816	816	816
[7]	250	250	250	250	250	250
[8]	200	200	200	200	200	200
[9]	1500	1700	1570	720	1050	1300
[10]	650	650	740	650	650	650
[11]	846	846	846	916	916	916
[12]	220-240 Vac 50Hz + PE	220-240 Vac 50Hz + PE	220-240 Vac 50Hz + PE	220-240 Vac 50Hz + PE	220-240 Vac 50Hz + PE	220-240 Vac 50Hz + PE
[13]	0,892	1,056	1,889	2,072	2,871	2,455
[14]	187,2	209,9	204	312,6	414,3	470,2
[15]	610	610	590	590	590	590
[16]	B [16°C @ 80%RH] - [35°C @ 75%RH]	B [16°C @ 80%RH] - [35°C @ 75%RH]	B [16°C @ 80%RH] - [35°C @ 75%RH]	B [16°C @ 80%RH] - [35°C @ 75%RH]	B [16°C @ 80%RH] - [35°C @ 75%RH]	B [16°C @ 80%RH] - [35°C @ 75%RH]
[17]	0,975	1,105	1,162	0,468	0,683	0,845
[18]	0,743	0,850	0,911	0,234	0,383	0,495
[19]	519	598	620	140	243	322
[20]	426	492	506	116	203	270
[21]	-18	-18	-18	-35	-35	-35
[22]	<70	<70	<70	<70	<70	<70
[23]	67	77	77	46	59	67

	UNI 11- 2BC110A	UNI 21- 2BD110A	UNI 31- 2BC110A	UNI 41- 2BD110A	UNI 51- 2BD110A	EL 22- 6BC11EA
[1]	ICFS	ICFS	ICFS	ICFS	ICFS	ICFS
[2]	R290	R290	R290	R290	R290	R600a
[3]	65	74	81	90	95	65
[4]	520	850	1100	1300	1500	606
[5]	450	450	450	450	450	536
[6]	745	745	745	745	745	696
[7]	250	250	250	250	250	250
[8]	200	200	200	200	200	200
[9]	720	1050	1300	1500	1700	720
[10]	650	650	650	650	650	650
[11]	845	845	845	845	845	845
[12]	220-240 Vac 50Hz + PE	220-240 Vac 50Hz + PE	220-240 Vac 50Hz + PE	220-240 Vac 50Hz + PE	220-240 Vac 50Hz + PE	220-240 Vac 50Hz + PE
[13]	2,072	2,871	2,455	2,354	2,338	0,904
[14]	312,6	414,3	470,2	440,1	502,4	119,9
[15]	590	590	590	590	590	610
[16]	B [16°C @ 80%RH] - [35°C @ 75%RH]	B [16°C @ 80%RH] - [35°C @ 75%RH]	B [16°C @ 80%RH] - [35°C @ 75%RH]	B [16°C @ 80%RH] - [35°C @ 75%RH]	B [16°C @ 80%RH] - [35°C @ 75%RH]	B [16°C @ 80%RH] - [35°C @ 75%RH]
[17]	0,468	0,683	0,845	0,975	1,105	0,468
[18]	N/A	N/A	N/A	N/A	N/A	N/A
[19]	130	226	300	360	416	200
[20]	116	203	270	323	376	177
[21]	-45	-45	-45	-45	-45	-18
[22]	<70	<70	<70	<70	<70	<70
[23]	46	59	67	74	80	43

	EL 35- 6BC11EA	EL 45- 6BC11EA	EL 53- 6BC11EA	EL 61- 6BC11EA	EL 71- 6BD11EA
[1]	ICFS	ICFS	ICFS	ICFS	ICFS
[2]	R600a	R600a	R600a	R290	R600a
[3]	87	92	117	119	125
[4]	936	1186	1386	1700	1686
[5]	536	536	536	536	576
[6]	696	696	696	696	741
[7]	250	250	250	250	250
[8]	200	200	200	200	200
[9]	1050	1300	1500	1700	1800
[10]	650	650	650	650	690
[11]	845	845	845	845	845
[12]	220-240 Vac 50Hz + PE	220-240 Vac 50Hz + PE	220-240 Vac 50Hz + PE	220-240 Vac 50Hz + PE	220-240 Vac 50Hz + PE
[13]	0,928	0,937	1,347	1,139	1,262
[14]	121,9	127,1	175,8	163,4	185,7
[15]	610	610	610	610	610
[16]	B [16°C @ 80%RH] - [35°C @ 75%RH]	B [16°C @ 80%RH] - [35°C @ 75%RH]	B [16°C @ 80%RH] - [35°C @ 75%RH]	B [16°C @ 80%RH] - [35°C @ 75%RH]	B [16°C @ 80%RH] - [35°C @ 75%RH]
[17]	0,683	0,845	0,975	1,105	1,242
[18]	N/A	N/A	N/A	N/A	N/A
[19]	323	416	491	566	691
[20]	279	361	426	492	564
[21]	-18	-18	-18	-18	-18
[22]	<70	<70	<70	<70	<70
[23]	54	64	67	77	85

3.3.1 Lifespan, the machine

The machine is expected to function for 5-8 years.

3.4 Use, placement, and arrangement

To fully benefit from the machine, it is important that it is positioned correctly. Even with careful maintenance of the machine, faults can arise, without any specific person being held responsible, such that the product is damaged. It is therefore advisable to take out a deep-freeze insurance to have any potential loss covered.

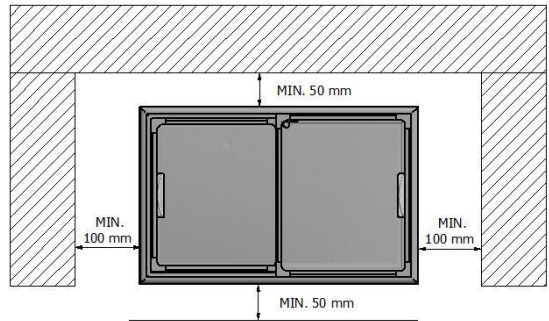

Figure 2 – Placement of freezer

The machine should not be used by weakened individuals (including children) with reduced physical, sensory, or diminished mental capacity, or without experience and knowledge unless they have received instructions and guidance by a person responsible for their safety. Children should be instructed under all circumstances not to play with the machine.

The machine must not be placed where it is exposed to water splashes, very high humidity, or in direct sunlight, as this may cause disruptions in operations and reduce the lifespan of the components. The machine must be set up on a horizontal surface and must not be placed against hot surfaces. The distances between the machine and surrounding items must be as shown by Figure 2.

4 Transport, Handling, and Storage



When transporting the machine, for example, using a sack truck, place the center of gravity as centrally as possible over the sack truck.



Be aware of the risk of pinching that occurs during the transport of the machine and ensure that the machine does not tip over or tip.

- Exercise caution during transport.
- Establish a full overview of the transport area.
- Keep the nearby area clear of people who are not part of the task.

When transporting the freezer, it must only be done in an upright position (with the lid facing upwards).

4.1.1 Personal Protective Equipment

When parts are transported and handled, the following personal protective equipment should be used:

	Protection Gloves
	Safety shoes

Use protective gloves when working where the hands are at risk.

Use safety shoes where there is a risk of objects falling and where feet are generally at risk.

4.1.2 Education and Equipment

Equipment Requirements:

Lifting equipment must meet the following minimum requirements:

- Check that the equipment has sufficient lifting capacity.

4.2 Storage

4.2.1 Environmental Conditions for Storage

During storage, the machine or machine parts must be stored under the same environmental conditions as during operation, see the section on Operational Limitations.

If a machine is turned off and put aside for a period, the lid should not be closed, as there must be circulation in the inner container. If there is no circulation in the machine, the inner container may become discolored. If the machine has been idle for an extended period, it must be cleaned as described in the section before it is used again.

5 Assembly, Installation, and Commissioning



This section provides instructions for the connection and commissioning of the machine. Waste from the assembly and installation of the machine must be handled in accordance with applicable national and regional regulations, see the section on Disposal, Destruction, and Recycling.

5.1 Electrical Power Supply Connection

Connections must be de-energized during the connection process and secured against accidental power supply. Furthermore, the connection must comply with the laws of the respective country concerning extra protection. In case of doubt, contact a professional.

The connection must be suitable for the machine's electrical specifications and load, see the section on Power Supply - Electrical.

5.2 Commissioning

If the compressor does not start when the voltage is connected, the likely reason is that the supply voltage to the machine is not intact. Check if there is voltage at the switch or if a fuse has blown.



The operation of the machine must correspond to the machine's intended use.

See the section Intended use.

- Check the conformity between the use of the machine and the intended use before commissioning.

6.1 Controls

The operation of the machine can be located in two places. Below you can find what applies to your unit.

	Correct setting of the thermostat
	<p>An unnecessarily low temperature in the machine increases energy consumption. Therefore, find a reasonable/appropriate thermostat setting.</p> <p>The goods placed in the box must be frozen to at least -20°C, as the machine is not sold as a freezing box. If the goods are only -15°C, it will cause the temperature of the other goods to rise, and in this case, it does not help to set the thermostat higher.</p>

6.1.1 Front Panel

A multifunction panel at the front of the freezer that contains the controls for the freezer.

6.1.1.1 Internal light

The freezer may be equipped with interior lighting. To operate it, use the I/O button on the front panel.



6.1.1.2 Manual thermostat

The freezer may be equipped with one or two thermostats as well as a selection of lamps.

6.1.1.2.1 The thermostat





The thermostats are adjusted by turning them clockwise to set them colder and counterclockwise to set them warmer.



6.1.1.2.2 Lamps (Optional)

	Power connected
	Freezing (Forces the compressor to run constantly)
	Temperature alarm (When the box is warmer than -14°C)

6.1.1.3 Electronic Thermostat



SET	To display the setpoint Used in programming mode to confirm a selection.
	NOT IN USE.
	(UP) To view the maximum temperature in memory. In programming mode, used to increase the displayed value.
	(DOWN) To view the minimum temperature in memory. In programming mode, used to lower the displayed value.
	To turn the controller on and off.
	NOT IN USE.

LED	MODE	FUNCTION
	ON	Compressor activated
	Flashing	Anti-short cycle delay activated
	ON	An alarm is active
°C/°F	ON	Unit of measurement
	Flashing	Programming phase

6.1.1.3.1 See setpoint

1. Press and immediately release the SET button to display the setpoint on the controller.
2. Press and release the SET button again immediately, or wait 5 minutes, and the probe's temperature will be displayed again.

6.1.1.3.2 Setting the setpoint

1. Hold down the SET button for more than 2 seconds to change the setpoint value.
2. The value of the setpoint will be displayed, and "°C" or "°F" will blink.
3. To change the value, press the UP or DOWN button within 10 seconds.
4. To save the new setpoint, press the SET button again or wait 10 seconds.

6.1.1.3.3 Minimum and Maximum Temperature Memory

The controller has a memory feature to save the hottest and coldest temperature readings.

6.1.1.3.3.1 See Min. temperature

1. Press and release **DOWN**.
2. **LO** will be displayed on the screen followed by the coldest measured temperature.

6.1.1.3.3.2 See Max. temperature

1. Press and release **UP**.
2. **HI** will be displayed on the screen followed by the highest measured temperature.

6.1.1.3.3.3 Reset temperature memory

1. Hold the set button for more than 3 seconds while the **HI** or **LO** temperatures are displayed, and "rSt" will be shown on the display.
2. To confirm the reset, "rSt" will start to blink on the display, and the probe temperature will be shown again.

6.1.1.4 Internal light

The freezer may come with an internal light; to operate this, use the I/O button.

6.1.1.5 Thermostat

Temperature regulation is done using the thermostat located in the compressor compartment, see Figure 3. The higher the number the thermostat is set to, the colder it will get inside the machine.



Figure 3 – Adjusting the Thermostat

6.2 Replenishment

Place the item in the machine. Remember that these items must be at least -20°C . The items must not be placed above the marked line found inside the machine, see Figure 4; otherwise, the items cannot be maintained at the temperature the machine is intended for (-18°C).



Figure 4 – Load line

6.2.1 Starting and Shutting Down the Machine

If the machine is taken out of service for an extended period, the storage instructions must be followed, see the section Environmental Conditions for Storage.

7 Inspection, testing, and maintenance



Repair and maintenance personnel must, before commencement of work, be instructed in hidden dangers, such as electrical hazards and pinch points.



Before starting repair, maintenance, etc., the pressurized systems of the machine must be disconnected and depressurized, electrical supply must be turned off, and the plug must be removed. This prevents unintended start-ups and contact with live parts.

In operational situations where the staff has disassembled parts of the machine, handles spare parts or tools, these individuals must be instructed to exercise special caution towards, among other things, moving parts.

	Danger of hydrocarbon release!
	Hydrocarbons are flammable and can result in uncontrolled fire if introduced to an ignition source.

Maintenance personnel working with the maintenance, draining, and/or refilling of hydrocarbons must be familiar with the associated dangers.

Personnel should also be acquainted with the conditions regarding ventilation, air-supplied respirators, etc.

	Protective equipment when handling hydrocarbons
	Use personal protective equipment as described in the safety data sheet for the refrigerant used, see annex.
	No open flame Open flames and smoking around the machine are not permitted because hydrocarbons are flammable and are used as refrigerant in the machine.

7.1 Used substances, properties

The machine contains one of the following hydrocarbons:

- R290 (Propane)
- R600A (Isobutane)

7.2 Safe execution of maintenance operations



The following precautions apply to the machine:

- Bring additional lighting during maintenance where necessary to establish safe working conditions.
- Establish safe work environments where necessary (e.g., signage, barricading, etc.)
- Gain an overview of the connection and disconnection processes for the machine before maintenance begins.
- Be familiar with and comply with prescribed setting, service, and inspection activities, including information on parts replacement.

7.2.1 Personal protective equipment

Appropriate protective equipment must be used according to the given maintenance task to be performed. For this, the instructions for personal protective equipment in the Safety section must be followed, as well as the required protective equipment when using tools, auxiliary equipment, etc.

General instructions for personal protective equipment are as follows:

	<p>Safety shoes</p> <p>Wear safety shoes in areas where there is a risk of objects falling and where the feet are generally at risk.</p>
	<p>Safety glasses</p> <p>Wear safety glasses during maintenance and cleaning of the machine, and where eyes are exposed to risk.</p>

7.2.2 Lifting and handling of machine parts



For lifting operations, approved lifting equipment must be used, such as cranes and hoists, chains or straps, when handling machine parts or components over 25 kg.

7.3 Energy Control

7.3.1 Disconnection and Lockout

	Risk of accidental start
	Dangerous situations can arise from unexpected or unintentional activation of the power supply while individuals are working on machinery. This can cause serious injury or death.

Before access is gained to the hazardous parts for the purpose of carrying out repair or maintenance, the power supply must be disconnected. If work is to be done on the electrical parts, a voltage-free condition must be established (measured) before the work commences.

	Disconnection of Power Supply
	Before starting repairs, maintenance, etc., energy sources must be disconnected. <ol style="list-style-type: none">1. Turn off the machine.2. Disconnect the electrical supply by pulling the plug out of the outlet..
	Retention of the Power Supply
	If it is not possible to maintain an overview of the entire machine and its plug during, for example, maintenance, the machine must be protected against accidental restart by using a locking device.

7.4 Inspections, Testing, and Maintenance of the Machine and Its Components

If the machine is not freezing, the following should be checked before calling a service technician:

- Is the machine connected to power
- Insufficient freezing capacity
 - Were the items placed in the machine cold enough?
 - Is the ventilation grille cleaned?
 - Is the machine correctly positioned according to the free space around the machine?

- Is the thermostat correctly set?

If the above does not remedy the problem, the supplier should be contacted.

If the power cord is damaged, it must be replaced by the manufacturer, a service partner, or another similarly qualified person, to avoid hazards.

	Warning!
	Risk of electric shock! There may be a transition to the frame if electrical cables are damaged.

The following general precautions should be considered before the machine is put into operation:

- Electrical cables and their enclosures must be intact and undamaged.
- The necessary power supply is present.

Component/Machine Part:	Frequency:	How:	Accept / not-accept:	Act:	I/A/M I = Inspection A = Testing M = Measurement
-------------------------	------------	------	----------------------	------	---

Safety-relevant inspection, testing, and maintenance

All safety-relevant inspections, testing, and maintenance must be directly integrated into the schedule from the original instructions for use.

Safety symbols and pictograms	Yearly	Inspect the markings on the machine according to their location as indicated in the section Placement of Safety Symbols.	Symbols must be clear, undamaged, and legible.	If markings are missing, damaged, or illegible, they must be replaced with new ones.	I
-------------------------------	--------	--	--	--	---

Electrical: General inspection, testing, and maintenance

Cables and electrical enclosures	Yearly	Visual inspection of cables, stress reliefs, conduits, and enclosures.	Damaged insulation/enclosures for electrical equipment.	If there is a fault in the insulation, the cable or conduit must be replaced while the machine is in a de-energized state. After dismantling or maintenance, the equipotential bonding connections must be reinstalled.	I
----------------------------------	--------	--	---	--	---

Labelling	Yearly	Visual inspection	Missing or damaged/illegible/faded labelling.	Labelling must be replaced/restored in accordance with the electrical documentation.	
-----------	--------	-------------------	---	--	--

Mechanical: Inspection, testing, and maintenance

Component/Machine Part:	Frequency:	How:	Accept / not-accept:	Act:	I/A/M I = Inspection A = Testing M = Measurement
<p>Safety-relevant inspection, testing, and maintenance</p> <p>All safety-relevant inspections, testing, and maintenance must be directly integrated into the schedule from the original instructions for use.</p>					
Fixed screens	Yearly	<p>Visual Inspection</p> <p>Conduct a check of the screen's fastening with the machine's power supply disconnected.</p> <p>Verify that the screen is correctly mounted and intact.</p>	<p>Missing/Defective/Loose/Deformed Shielding or Loose Fasteners</p> <p>Missing Attachment (e.g., hinge)</p> <p>Check that the screen has not been modified and that it is positioned as intended by the manufacturer.</p>	The machine is decommissioned and the shielding is restored.	I/A

	<p>Attention</p> <p>Completed inspection, testing, and maintenance must be recorded! (for example, in a log). The document should be easily accessible and located in a known place for all machine users.</p>
---	---

7.5 Spare Parts/Accessories

Contact the supplier/dealer.



8.1.1 Interruption, relief, or isolation of energy

	Interruption of power supply
The plug is disconnected before cleaning work begins. See the section on Interruption and Lockout.	

8.1.2 Cleaning Procedures - General Cleaning

Cleaning should be carried out as needed to ensure that the machine operates optimally and with minimal energy consumption. If the machine is located in an exposed area, there will be a lot of dirt on the ventilation grills and in the compressor room. This dirt must be removed. If it is not removed, there is a risk that the machine will not work, and it will not be cool. Likewise, the compressor can burn out. In these cases, the warranty does not apply.

	Interruption of power supply
Remember to disconnect the power to the machine before cleaning starts. See the section on Interruption and Lockout.	

Cleaning of the compressor room is done with a vacuum cleaner, without touching the installations found in the compressor room, see Figure 5. The rest of the cleaning is done with a mild soap solution. Soda-containing cleaning agents must not be used, as they damage the inner container.



Figure 5 – Cleaning of the compressor room

8.1.2.1 Personal Protective Equipment

	Personal Protective Equipment When Using Cleaning Agents
<p>Use personal protective equipment as described in the safety data sheet for the cleaning agent used.</p>	

Personal protective equipment must be used in accordance with the individual product data sheets/safety data sheets in connection with:

- General cleaning.
- Handling/use of chemicals.

8.1.3 Cleaning Procedures - Defrosting

To ensure that the box operates optimally and with minimal energy consumption, it should be defrosted when a layer of frost about 2 mm thick forms on the sides. Defrosting should be carried out with a plastic scraper. It is important not to use materials that could damage the inner container.

Frost formation in the machine is determined by air humidity and the usage of the machine. During cleaning, meltwater can be discharged through the meltwater drain located on the front of the machine, see Figure 6.

Remember to close the meltwater drain after cleaning.



Figure 6 – Drain for meltwater outlet

8.1.4 Extra Cleaning Procedures - FOCUS

To ensure hygiene in the FOCUS freezer, it is required that the sliding tracks for the glass are cleaned regularly. This cleaning should be done with a vacuum cleaner and a cotton swab moistened with a mild soap solution. Soda-based cleaning agents must not be used as they can damage the inner container.



9.1 Disconnection, Relieving, or Isolation of Energy Sources

	Disconnection of Energy Supply
The supply isolator is set to the off position and locked before dismantling begins.	
See the section Disconnection and lockout	

9.2 Special risk reduction measures

The machine is dismantled, sorted, and disposed of in categories as required by the applicable environmental requirements at the time of scrapping.

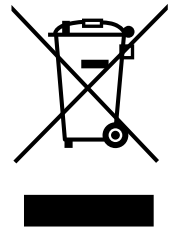

The product is subject to Directive 2012/19/EU on waste electrical and electronic equipment (WEEE).

The product must not be disposed of with unsorted household waste. Use the local WEEE collection points for the disposal of this product, and ensure that all relevant regulations are complied with.



9.3 Personal Protective Equipment

Appropriate protective equipment must be used due to the work assessment prior to dismantling, as well as any required protective gear when using tools, auxiliary equipment, etc. General instructions for personal protective equipment are as follows:

	<p>Head protection</p> <p>Use head protection where there is a risk of objects falling and the head is generally exposed.</p>
	<p>Safety shoes</p> <p>Use safety footwear where there is a risk of objects falling, and the feet are generally exposed.</p>
	<p>Safety gloves</p> <p>Use safety gloves during the dismantling of the machine, and where hands are exposed to risk.</p>

9.4 Sequence or time schedule for decommissioning operations

The owner must take measures to reduce the amount of waste, especially by using environmentally friendly technology and products that can be recycled and reused.

9.5 Dismantling

Before dismantling the machine, a comprehensive plan for the dismantling process must be prepared. This plan should include a risk assessment for the work as well as for the disposal of machines and machine parts.

The risk assessment should cover the following aspects:

- Disconnecting power sources.
- Hidden hazards (e.g., potential stored energy).
- Sequence of dismantling steps.
- Suitable means (stabilizing, lifting/crane/truck).
- Division of machine parts.
- Proper disposal/recycling.

The plan and risk assessment must be prepared in accordance with the regulations in effect at the time of dismantling.

Before beginning the dismantling, a de-energized state must be verified using appropriate measuring equipment.

During dismantling, the machine's specified lifting and attachment points must be used. Refer to the Transport, Handling, and Storage section.

9.6 Disposal, Destruction, and Recycling

It is the owner's responsibility to ensure that waste is disposed of and recycled properly.

When disposing of materials, careful sorting must be carried out:

- **Materials:** The machine frame and all mechanical plant and machine components are made of steel, light metal, and plastic. These materials must be delivered for recycling. This also applies to non-metal, composite materials, and consumables.
- **Problematic substances** such as batteries, accumulators, cables, electronic waste, and circuit boards must be delivered to sites that accept this type of waste.
- **Drained fluids:** such as coolants, oils, and greases must also be delivered to sites that accept this type of waste.

When disposing of waste and used parts, one must always comply with applicable national and regional regulations regarding health, safety, and the environment



10 Documents and Drawings

10.1 Copy of the CE Declaration of Conformity



EU Declaration of Conformity (DoC)



Declaration number: Konform 02 udg. 21

Manufacture: Flcold Fryserne Hobro ApS
Løgstørvej 81, Hørby, DK-9500 Hobro

Declare that the following products:

CVG22, CVG35, CVG45, CVG53, CVG61,
CVG22 Combi, CVG35 Combi, CVG45 Combi, CVG53 Combi, CVG61 Combi,
CVGT22, CVGT35, CVGT45, CVGT53, CVGT61,
EL22, EL35, EL45, EL53, EL59, EL61, EL71,
FCF305, FCF405, FCF505, FCF605
LHF460, LHF540, LHF620
Focus 73, Focus 106, Focus 131, Focus 151, Focus 171,
Focus 73 Combi, Focus 106 Combi, Focus 131 Combi, Focus 151 Combi, Focus 171 Combi,
UNI 11, UNI 21, UNI 31, UNI 41, UNI 51,
UNI-S 11, UNI-S 21, UNI-S 31,
GLE10, GLE20, GLE30, GLE40, GLE50,
E11 MOBILUX, E21 MOBILUX.
NOVA22, NOVA35, NOVA45, NOVA53, NOVA61.
CUBE22, CUBE35, CUBE45, CUBE53, CUBE61.
NOVA22 Combi, NOVA35 Combi, NOVA45 Combi, NOVA53 Combi, NOVA61 Combi.
CUBE22 Combi, CUBE35 Combi, CUBE45 Combi, CUBE53 Combi, CUBE61 Combi.

As delivered, the object of declaration described above is in conformity with the requirements of the following documents:

2014/30/EU (Electromagnetic Compatibility)

EN 55014-1:2017 – Electromagnetic compatibility - Requirements for household appliances, electric tools and similar apparatus - Part 1: Emission

EN 55014-1:2017/A11:2020 – Electromagnetic compatibility - Requirements for household appliances, electric tools and similar apparatus - Part 1: Emission

EN 61000-3-3:2013 – Electromagnetic compatibility (EMC) - Part 3-3: Limits - Limitation of voltage changes, voltage fluctuations and flicker in public low-voltage supply systems, for equipment with rated current ≤ 16 A per phase and not subject to conditional connection

EN 61000-3-3:2013/A1:2019 – Electromagnetic compatibility (EMC) - Part 3-3: Limits - Limitation of voltage changes, voltage fluctuations and flicker in public low-voltage supply systems, for equipment with rated current ≤ 16 A per phase and not subject to conditional connection

EN 61000-3-3:2013/A2:2021 – Electromagnetic compatibility (EMC) - Part 3-3: Limits - Limitation of voltage changes, voltage fluctuations and flicker in public low-voltage supply systems, for equipment with rated current ≤ 16 A per phase and not subject to conditional connection

EN 61000-3-3:2013/A2:2021/AC:2022 – Electromagnetic compatibility (EMC) - Part 3-3: Limits - Limitation of voltage changes, voltage fluctuations and flicker in public low-voltage supply systems, for equipment with rated current ≤ 16 A per phase and not subject to conditional connection

2014/35/EU (Low voltage Directive)

EN 60335-1:2012 – Household and similar electrical appliances - Safety - Part 1: General requirements

EN 60335-1:2012/AC:2014 – Household and similar electrical appliances - Safety - Part 1: General requirements

EN 60335-1:2012/A11:2014 – Household and similar electrical appliances - Safety - Part 1: General requirements

EN 60335-1:2012/A13:2017 – Household and similar electrical appliances - Safety - Part 1: General requirements

EN 60335-1:2012/A1:2019 – Household and similar electrical appliances - Safety - Part 1: General requirements

EN 60335-1:2012/A14:2019 – Household and similar electrical appliances - Safety - Part 1: General requirements



EN 60335-1:2012/A2:2019 – Household and similar electrical appliances - Safety - Part 1: General requirements
EN 60335-1:2012/A15:2021 – Household and similar electrical appliances - Safety - Part 1: General requirements

EU 517/2014 (F-Gas regulation)

2009/125/EC Framework for the setting of ecodesign requirements for energy-related products

EN ISO 22043:2020 – Ice-cream freezers — Classification, requirements and test conditions

EU 2017/1369 Setting a framework for energy labelling

2006/42/EC (Machinery Directive)

EN 60335-1:2012 – Household and similar electrical appliances - Safety - Part 1: General requirements
EN 60335-1:2012/AC:2014 – Household and similar electrical appliances - Safety - Part 1: General requirements
EN 60335-1:2012/A11:2014 – Household and similar electrical appliances - Safety - Part 1: General requirements
EN 60335-1:2012/A13:2017 – Household and similar electrical appliances - Safety - Part 1: General requirements
EN 60335-1:2012/A1:2019 – Household and similar electrical appliances - Safety - Part 1: General requirements
EN 60335-1:2012/A14:2019 – Household and similar electrical appliances - Safety - Part 1: General requirements
EN 60335-1:2012/A2:2019 – Household and similar electrical appliances - Safety - Part 1: General requirements
EN 60335-1:2012/A15:2021 – Household and similar electrical appliances - Safety - Part 1: General requirements
EN 60335-2-89:2010 – Household and similar electrical appliances - Safety - Part 2-89: Particular requirements for commercial refrigerating appliances with an incorporated or remote refrigerant condensing unit or compressor
EN 60335-2-89:2010/A1:2016 – Household and similar electrical appliances - Safety - Part 2-89: Particular requirements for commercial refrigerating appliances with an incorporated or remote refrigerant condensing unit or compressor
EN 60335-2-89:2010/A2:2017 – Household and similar electrical appliances - Safety - Part 2-89: Particular requirements for commercial refrigerating appliances with an incorporated or remote refrigerant condensing unit or compressor
EN 378-2:2016 – Refrigerating systems and heat pumps - Safety and environmental requirements - Part 2: Design, construction, testing, marking and documentation
ISO 5149-2:2014 – Refrigerating systems and heat pumps — Safety and environmental requirements — Part 2: Design, construction, testing, marking and documentation
ISO 5149-2:2014/AMD 1:2020 – Refrigerating systems and heat pumps — Safety and environmental requirements — Part 2: Design, construction, testing, marking and documentation

1907/2006/EC Chemical substances (REACH)

2011/65/EU Restriction of the use of certain hazardous substances (RoHS)

EN IEC 63000:2018 – Technical documentation for the assessment of electrical and electronic products with respect to the restriction of hazardous substances

2014/68/EU Pressure Equipment (PED)

EN 378-2:2016 – Refrigerating systems and heat pumps - Safety and environmental requirements - Part 2: Design, construction, testing, marking and documentation

This declaration of conformity is issued under the exclusive responsibility of the manufacturer

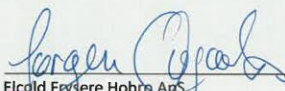

Elcold Frysere Hobro ApS
Asger Staunstrup, 09/11/2023
CEO

Elcold Frysere Hobro ApS
Finn Moltke Jensen, 09/11/2023
Product Director

10.2 Electrical documentation

Wiring diagram Commercial appliances with LST starting equipmen

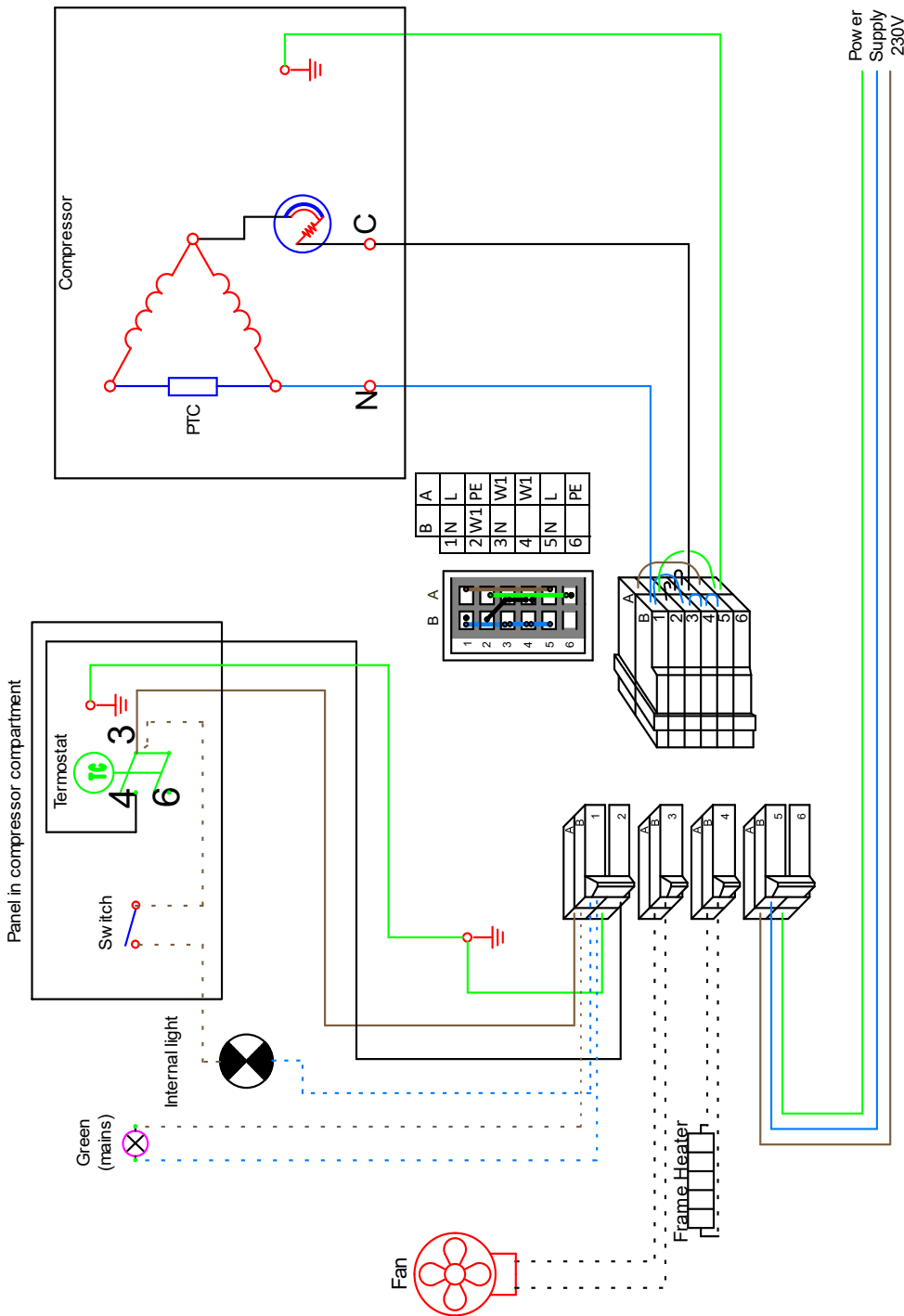
Dotted lines (- - - - -) indicates optional equipment



11 Appendix

11.1 List of Spare parts

11.1.1 CUBE

ITEM NO.	DESCRIPTION	CUBE 22	CUBE 35	CUBE 45	CUBE 53	CUBE 6
SLIDING LID						
1	UPPER LID	8011.0112	8011.0212	8011.0312	8011.0412	8011.0512
2	LOWER LID	8011.0113	8011.0213	8011.0313	8011.0413	8011.0513
3	GREY HANDLE FOR LID	82HÅND10				
4	MINI CASTORS UNDER LID (SET to 1 LID)	82PLASTD3 - 2pcs.				
		82PLASTD4 - 2 pcs.				
		82PLASTD5 - 4 pcs.				
5	DOWELS FOR LOCK (6 PCS)	82PLASTD6				
6	LOCK KIT COMPLETE	8100.0301				
7	LOCK HOLDER IN UPPER GLASS	82PLASTD31				
MOTOR COMPARTMENT						
8	COMPRESSOR 230V 50HZ R290	82EMC3117U	82EMC3121U	82EMC3125U	82EMC3134U	82EMC3140U
OTHER						
9	STOPPER FOR OUTSIDE DRAIN	82E1HU				
10	DIGITAL THERMOMETER	82FTERMOMETB2				
11	THERMOSTAT PANEL	82E35H				
12	THERMOSTAT R290	82THERMOSTAT11				
13	GRILL FOR ENGINE COMPARTMENT	82SP1417				
14	CASTORS 4 PCS KIT	8100.0200				
14	CASTORS 2 PCS WITH, 2 PCS W/O BRAKE	8100.0202				
15	FAN 110 - 240V	--			82BLAES9	

ITEM NO.	DESCRIPTION	CUBE 22	CUBE 35	CUBE 45	CUBE 53	CUBE 61
16	FILTER DRYER	82FILTER6XH9				
17	FRONT VENTILATION GRILL	82PLASTMFP13,15				

11.1.2 NOVA

ITEM NO.	DESCRIPTION	NOVA 22	NOVA 35	NOVA 45	NOVA 53	NOVA 61
SLIDING GLASS LID						
1	UPPER LID	8014.0104	8014.0204	8014.0304	8014.0404	8014.0504
2	LOWER LID	8014.0105	8014.0205	8014.0305	8014.0405	8014.0505
3	GREY HANDLE FOR LID	82HÅND10				
4	MINI CASTORS UNDER LID (SET to 1 LID)	82PLASTD3 - 2pcs.				
		82PLASTD4 - 2 pcs.				
		82PLASTD5 - 4 pcs.				
5	DO-WELS FOR LOCK (6 PCS)	82PLASTD6				
6	LOCK KIT COMPLETE	8100.0303				
7	LOCK HOLDER IN UPPER GLASS	82PLASTD33				
MOTOR COMPARTMENT						
8	COMPRESSOR 230V 50HZ R290	82EMC3117U	82EMC3121U	82EMC3125U	82EMC3134U	82EMC3140U
OTHER						

ITEM NO.	DE-SCRIPTION	NOVA 22	NOVA 35	NOVA 45	NOVA 53	NOVA 61
9	STOP- PER FOR OUT- SIDE DRAIN	82E1HU				
10	DIGITAL THER- MOME- TER	82FTERMOMETB2				
11	THER- MO- STAT PANEL	82E35H				
12	THER- MO- STAT R290	82THERMOSTAT11				
13	GRILL FOR EN- GINE COM- PART- MENT	82SP1417				
14	CA- STORS 4 PCS KIT	8100.0200				
14	CAS- TORS 2 PCS WITH, 2 PCS W/O BRAKE	8100.0202				
15	FAN 110 - 240V	--			82BLAES9	
16	FILTER DRYER	82FILTER6XH9				
17	FRONT VENTI- LATION GRILL	82PLASTMFP13,15				
INTERNAL LIGHT						
1	LED LIGHTS	82LED21	82LED16	82LED17	82LED18	82LED19
2	CLEAR LIGHT COVER	82P-PROFIL02				

ITEM NO.	DE-SCRIPTION	NOVA 22	NOVA 35	NOVA 45	NOVA 53	NOVA 61
3	POWER SUPPLY 115/230V	82PSU3				

11.1.3 FOCUS

ITEM NO.	DESCRIPTION	FOCUS 73	FOCUS 106	FOCUS 131	FOCUS 151	FOCUS 171
SLIDING GLASS LID						
1	COMPLETE SET OF GLASS LIDS (RED)	82GLASF07 3-S1	82GLASF10 6-S1	82GLASF13 1-S1	82GLASF15 1-S1	82GLASF17 1-S1
1	COMPLETE SET OF GLASS LIDS (BLUE)	82GLASF07 3-S2	82GLASF10 6-S2	82GLASF13 1-S2	82GLASF15 1-S2	82GLASF17 1-S2
1	COMPLETE SET OF GLASS LIDS (GREY)	82GLASF07 3-S3	82GLASF10 6-S3	82GLASF13 1-S3	82GLASF15 1-S3	82GLASF17 1-S3
2	HANDLE, SELF ADHESIVE (RED)	82HÅND1				
2	HANDLE, SELF ADHESIVE (BLUE)	82HÅND2				
2	HANDLE, SELF ADHESIVE (GREY)	82HÅND3				
3	PILE WEATHER STRIPS (2 PCS)	82GLASTAETNING1				
4	PLASTIC TRACK IN FRONT	82FORK10	82FORK11	82FORK12	82FORK13	82FORK14
5	PLASTIC TRACK IN BACK	82BAGK5	82BAGK6	82BAGK7	82BAGK8	82BAGK9
6	LOCK HOLDER IN UPPER GLASS	82PLASTD33				
7	LOCK KIT COMPLETE	8100.0303				
INTERNAL LIGHT						
8,9	COMPLETE INTERNAL LIGHT 115/230V	8100.0610	8100.0611	8100.0612	8100.0613	8100.0614
8	LED LIGHTS	82LED16	82LED17	82LED18	82LED19	82LED20
9	POWER SUPPLY 115V/60HZ + 230V/50HZ	82PSU3				

ITEM NO.	DESCRIPTION	FOCUS 73	FOCUS 106	FOCUS 131	FOCUS 151	FOCUS 171
10	CLEAR LIGHT COVER	9100.0625	9100.0626	9100.0627	9100.0628	9100.0629
MOTOR COMPARTMENT						
11	COMPRESSOR 230V 50HZ R290	82EMC311 7U	82EMC312 1U	82EMC312 5U	82EMC313 4U	82EMC314 0U
OTHER						
12	STOPPER FOR OUTSIDE DRAIN	82E1HU				
13	DIGITAL THERMOMETER	82FTERMOMETB2				
14	THERMOSTAT R290	82THERMOSTAT11				
15	GRILL FOR ENGINE ROOM - PLASTIC	82SP1417				
15	GRILL FOR ENGINE ROOM - METAL	82MHUSRIST				
16	FILTER DRYER	82FILTER6XH9				
17	CASTORS 4 PCS KIT	8100.0200				
17	CASTORS 2 PCS WITH, 2 PCS W/O BRAKE	8100.0202				
18	FAN 110 - 240V	--			82BLAES9	
19	FRONT VENTILATION GRILL	82PLASTMFP15				

11.1.4 FOCUS V

ITEM NO.	DESCRIPTION	FOCUS 73 V	FOCUS 106 V	FOCUS 131 V
LIFT-UP GLASS LID				
1	GLASS LID EXCL. HINGES	8016.0103	8016.0203	8016.0303
2	GASKET FOR GLASS LID	TÆT073VG	TÆT106VG	TÆT131VG
3	HINGE 4.6	----	----	2 x 82HA-ENG46
3	HINGE 4.2	2 x 82HAENG42		----
MOTOR COMPARTMENT				
4	COMPRESSOR 230V 50HZ R290	82EMC3117U	82EMC3121U	82EMC3125U
OTHER				
5	STOPPER FOR OUTSIDE DRAIN	82E1HU		
6	FRONT VENTILATION GRILL	82PLASTMFP15		
7	DIGITAL THERMOMETER	82FTERMOMETB2		
8	THERMOSTAT R290	82TERMOSTAT11		
9	THERMOSTAT PANEL	82E35H		
10	GRILL FOR ENGINE ROOM	82SP1417		
11	FILTER DRYER	82FILTER6XH9		
12	CASTORS 4 PCS KIT	8100.0200		
12	CASTORS 2 PCS WITH, 2 PCS W/O BRAKE	8100.0202		

11.1.5 CVG

ITEM NO.	DE-SCRIPTION	CVG 22	CVG 35	CVG 45	CVG 53	CVG 61
LIFT-UP GLASS LID						
1	GLASS LID EXCL. HINGES	8016.0100	8016.0201	8016.0301	8016.0400	8016.0500
2	ALU-HANDLE, ELOX	ALUHANDTAG				
3	GASKET FOR GLASS LID	82TAET22VG	82TAET35VG	82TAET45VG	82TAET53VG	82TAET61VG
4	HINGE CMV NO 34	82HAENG42	----	82HAENG42	82HAENG00	82HAENG00
4	HINGE CMV NO 34	----	HAENG49	HAENG49	HAENG46	HAENG46
4	HINGE CMV NO 34	HAENG49	HAENG49	HAENG49	HAENG49	HAENG49
4	HINGE CMV NO 34	----	----	----	HAENG49	HAENG49
MOTOR COMPARTMENT						
5	COMPRESOR 230V 50HZ R290	EMC3119U	EMC3121U	EMC3125U	EMC3134U	EMC3140U
OTHER						
6	STOPPER FOR OUTSIDE DRAIN	E1HU				
7	DIGITAL THERMOMETER	FTERMOMETB2				
8	THERMOSTAT PANEL	E35H				
9	THERMOSTAT R290	THERMOSTAT11				

10	GRILL FOR ENGINE COMPART.	SP1417	
11	CAPSTORS 4 PCS KIT	8100.0200	
12	FAN 110 - 240V	--	BLAES9
13	FRONT VENTILATION GRILL	PLASTMFP15	
14	DRYING FILTER 6 MM	FILTER6XH9	

11.1.6 EL

ITEM NO.	DESCRIPTION	EL 22	EL 35	EL 45	EL 53	EL 61	EL 71	
SOLID LIFTING LID								
1	HANDLE EL w/ LOCK	EPCH						
2	HINGE 0.0	----	----	H/ENG00	H/ENG00	H/ENG00	----	
2	HINGE 4.2	2 x HA-ENG42	----	----	----	----	----	
2	HINGE 4.6	----	2 x HA-ENG46	2 x HA-ENG46	----	----	----	
2	HINGE 4.9	----	----	----	2 x HA-ENG49	2 x HA-ENG49	2 x HA-ENG49	
3	HINGE COVER LARGE	HAENGKAPHV-L						
4	HINGE COVER SMALL	HAENGKAPHV-S						
6	E 14 BULP	E14220						
5	LIGHT SOCKET	FATNING						
7	COVER F/ LID LIGHT	E15H						
8	WHITE LID w/ HANDLE	8010.0105	8010.0205	8010.0303	8010.0404	8010.0500	8010.0601	
8	STAINLESS STEEL LID w/ HANDLE	8012.0106	8012.0206	8012.0306	8012.0406	8012.0506	8012.0700	
MOTOR COMPARTMENT								
17	COMPRES-SOR 230V 50HZ R600A	EMY80CLP			NLE15KK.4			
18	START CAPACITOR	EMY80CLPKL			--			
19	STARTING RELAY	EMY80CLPRE			103N0016			
CONTROL PANEL								
9	FRONT VENTILATION GRILL	PLASTMFP08						
9	FRONT VENTILATION GRILL	PLASTMFP05, 04						
10	LAMP GREEN ROUND	LAMPGRO						
11	LAMP RED ROUND	LAMPROD						
12	LAMP YELLOW ROUND	LAMPGUL						
13	THERMOSTATE BUTTON	PLASTD32						

ITEM NO.	DESCRIPTION	EL 22	EL 35	EL 45	EL 53	EL 61	EL 71	
14	THERMOSTAT R600A	THERMOSTAT15						
25	DIGITAL THERMOMETER	FTERMOMETB2						
OTHER								
21	GRILL F/ENGINE ROOM	SP1417						
20	DRYING FILTER 6 MM	FILTER6XH9						
22	FAN for 230V	BLAES230HBT						
	BASKET EL	KURVC150					----	
	BASKET EL 71	----						KURVC200F
15	STOPPER FOR OUTSIDE DRAIN	E1HU						
24	PARTITION	SKILLERUM1					----	
23	MOULDING F/PARTITION	STYRLIST1+0					----	
16	FOOT COMPLETE	SP1412+SP1413						

11.1.7 UNI

ITEM NO.	PCS	DE-SCRIPTION	UNI & UNI S				
			11	21	31	41	51
UNI and UNI-S							
1	4	Plastic foot	SP1412 SP1413				
2	1	Stopper for drain	E1HU				
4	1	Front ventilation grill	PLASTMFP13				
6	1	Bracket for fan	Beslag BL				
7	1	Precondensor	Forkondl1				
9	1	Filter dryer	Filter6XH9				
13	1	Cover for motor room	SP1417				
14	1	Square grill	E51H				
15	1	Wheels set(2 w. brake)	8100.0202				
16	1	Cable retainer	E59Aflast1				
17	1	Plug with two pins					
18	1	Plug with four pins					
3	1	Electronic thermostat 230V Incl. sensor	DIXELL30CH2				
5	1	Fan230V	BLAES230HBT				
8	1	Compressor 230V 50HZ, R290	NEU2140U	NEU2155U	NEU2168U	NT2180U	

ITEM NO.	PCS	DE- SCRIP- TION	UNI & UNI S				
			11	21	31	41	51
19	1	Multiplug with cable	TSK0104		TSK0102	TSK0101	TSK0102
11	1	Starting relay	NEU2140URE	NEU2155URE	NEU2168URE		
12	1	Starting capacitor	NEU2140USK	NEU2155USK	NEU2168USK		
		Motor protector/ KLIXON	NEU2140UKL	NEU2155UKL	NEU2168UKL		
20	1	Cover	103N2009				
10	1	Cord relief	103N1004				
Lid and accessories UNI							
1	1	Lid w/o hinges	8010.0100	8010.0200	8010.0302	8010.0402	8010.0502
2	1	Hinge w/o spring	-		Haeng 00		
3	1	Hinge set	2 x Haeng 42	2 x Haeng 46		2 x Haeng 49	
4	1	Plastic grip with lock	EPCH				
UNI-S							
1	1	Glass Lid upper with lock	8014.0100	8014.0202	8014.0302	8014.0402	8014.0502
1	1	Glass Lid lower with lock	8014.0101	8014.0203	8014.0303	8014.0403	8014.0503
1	1	CAL lid upper with lock	8011.0100	8011.0200	8011.0300	8011.0400	8011.0500
1	1	CAL lid lower with lock	8011.0101	8011.0201	8011.0301	8011.0401	8011.0501
5	6	Dowels (SG4 lock)	SP1993				
6	1	Lock kit complete	82CYL1SG 4				
6	2	Key	NØGLE2				

ITEM NO.	PCS	DE-SCRIPT-ION	UNI & UNI S				
			11	21	31	41	51
INTERNAL LIGHT							
1	1	LED LIGHTS	LED21	LED16	LED17	LED17	LED18
2	1	CLEAR LIGHT COVER	P-PROFIL02				
3	1	POWER SUPPLY 115/230V	PSU3				

11.2 Assembly drawings and diagrams

11.2.1 NOVA/CUBE

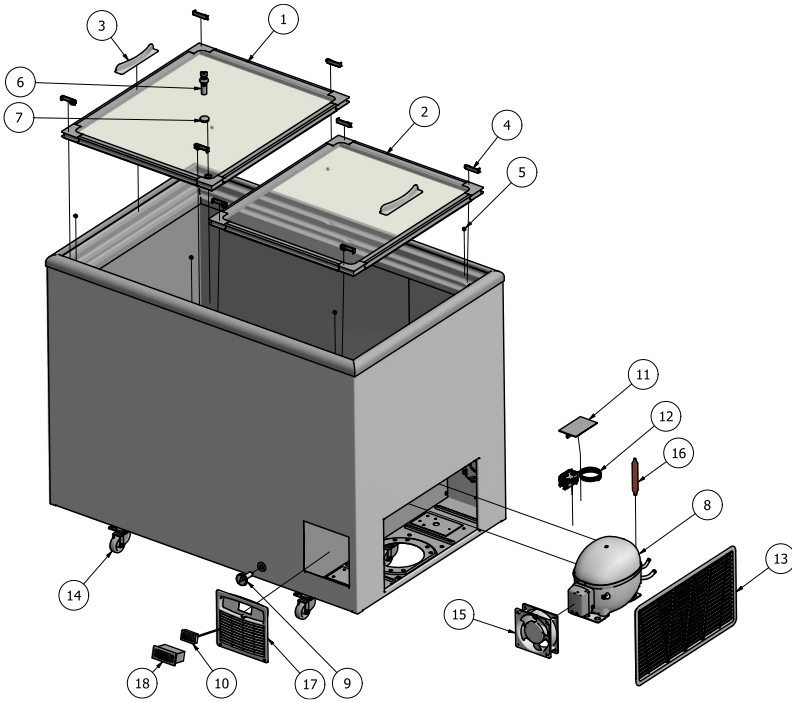

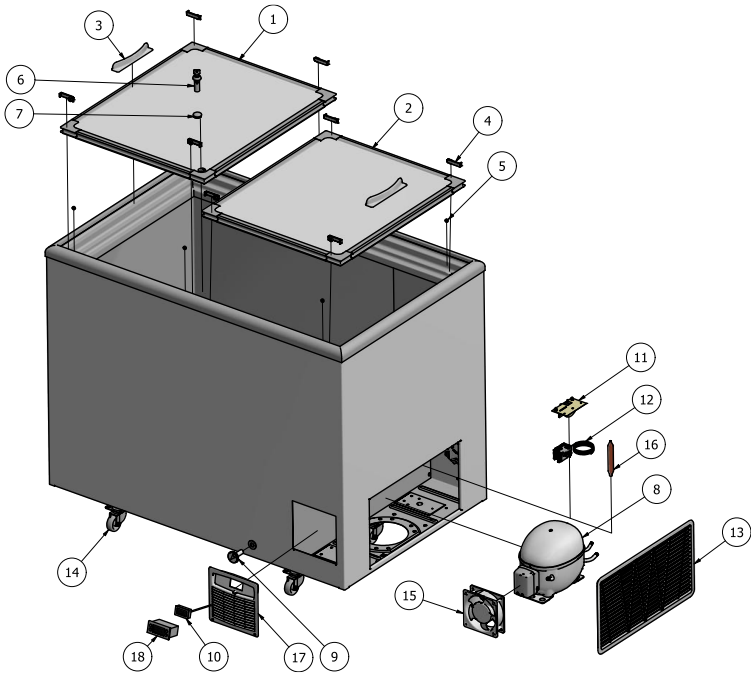

11.2.1.1 Internal lights NOVA

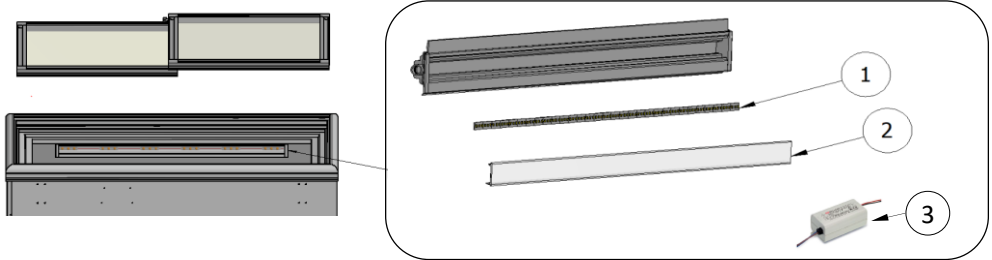

11.2.2 FOCUS, FOCUS V

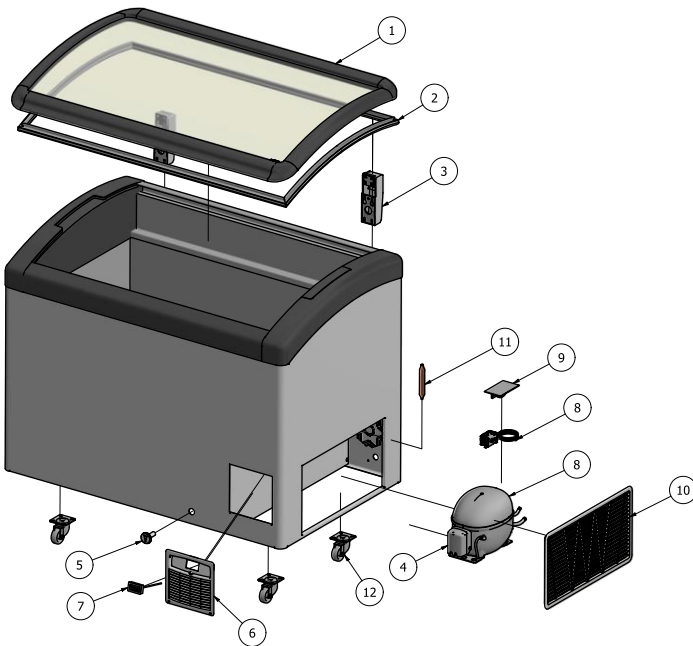
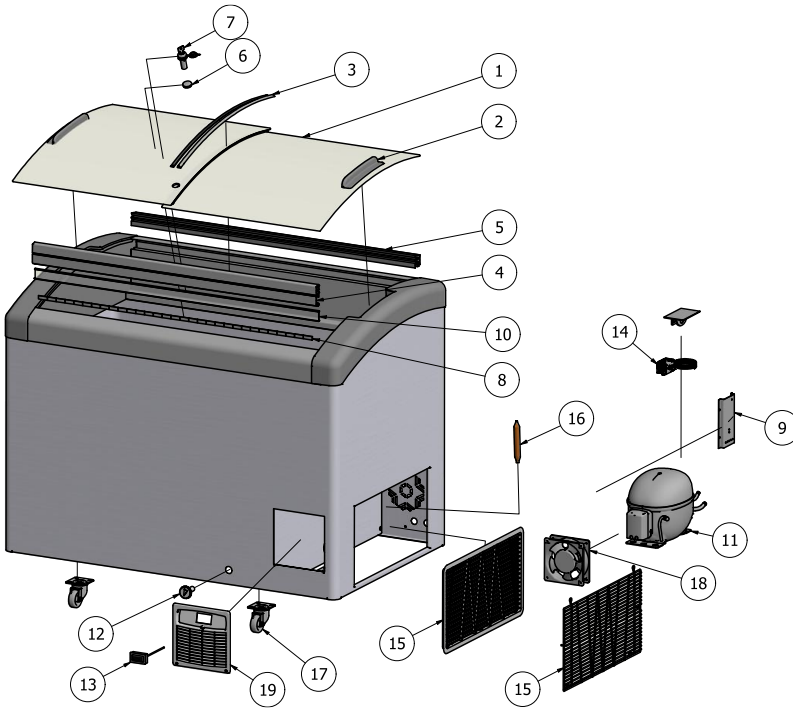

11.2.3 CVG

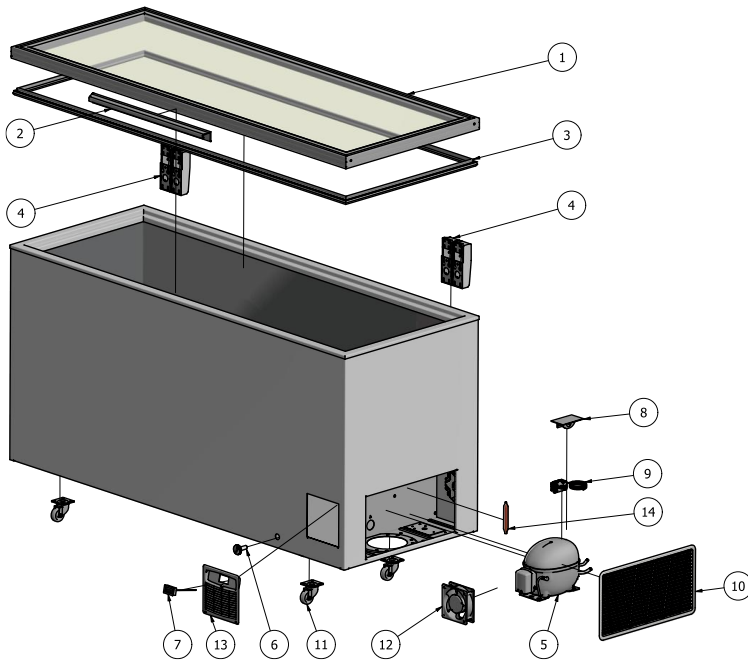

11.2.4 EL

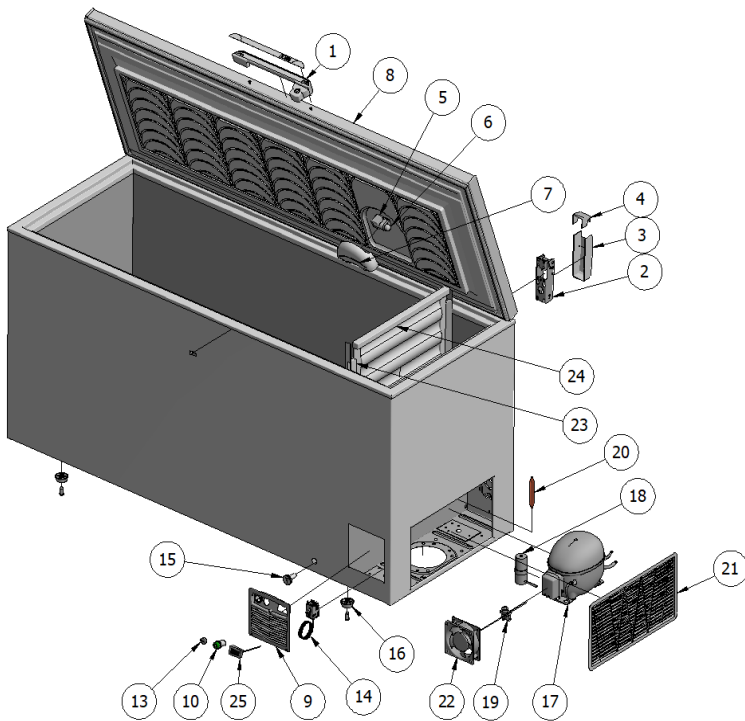

11.2.5 UNI (S)

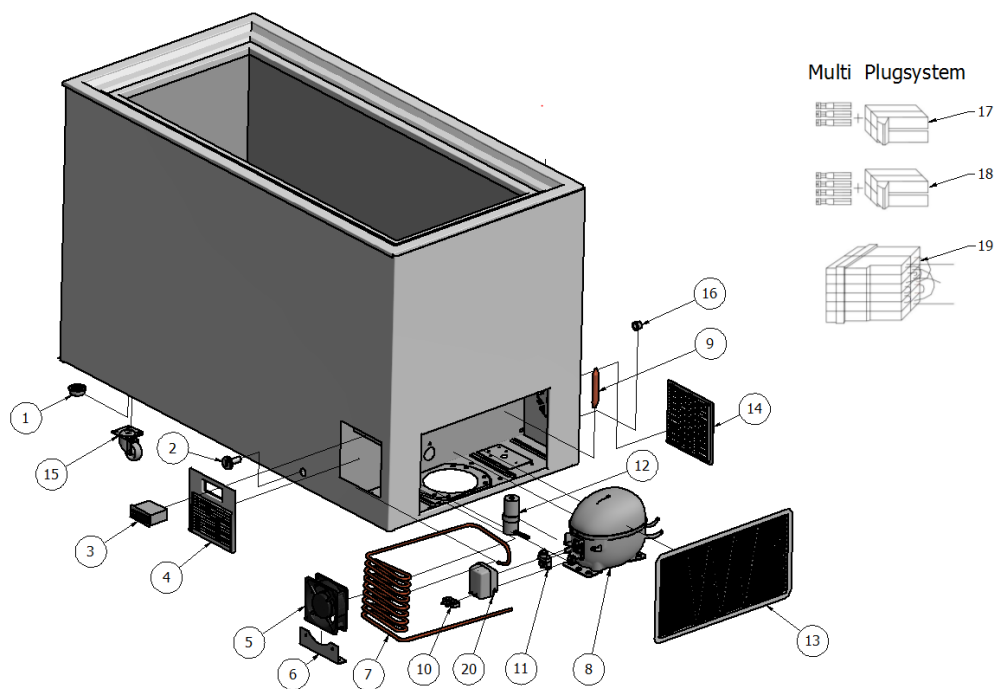

11.2.5.1 Lid for UNI

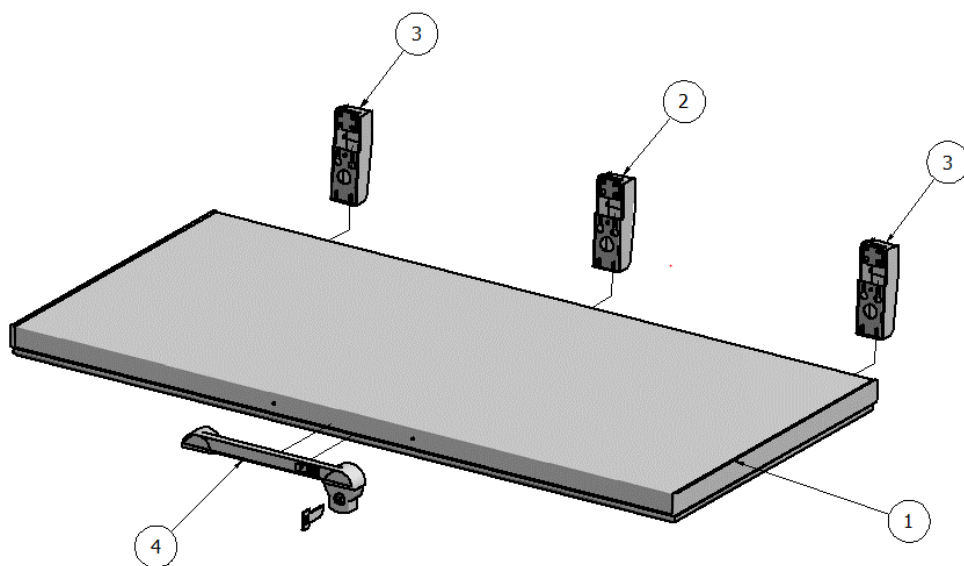

11.2.5.2 Lid for UNI-S

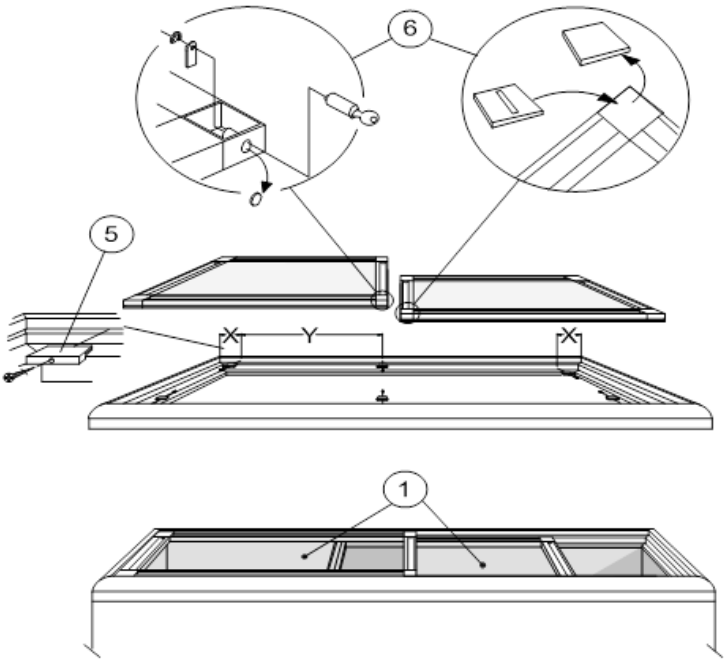

X = 100 mm

Y	{	22 = 165 mm
		35 = 340 mm
		45 = 460 mm
		53 = 535 mm
		51 = 645 mm

11.2.5.3 Internal lights UNI

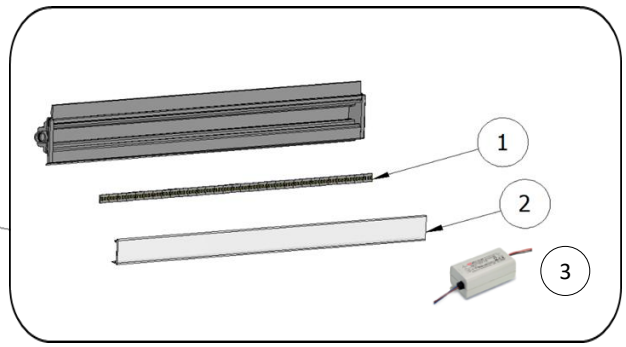
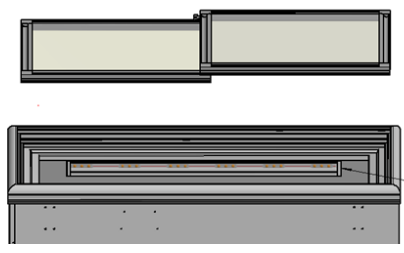

COMPANY WITH
MANAGEMENT SYSTEM
CERTIFIED BY DNV
ISO 9001 • ISO 14001



Elcold Frysere Hobro ApS Løgstørvej 81, Hørby DK-9500 Hobro Denmark

Tel. +45 96 57 22 22

elcold@elcold.com

www.elcold.com

